

ASSEMBLY INSTRUCTIONS
COASTER FINE FURNITURE

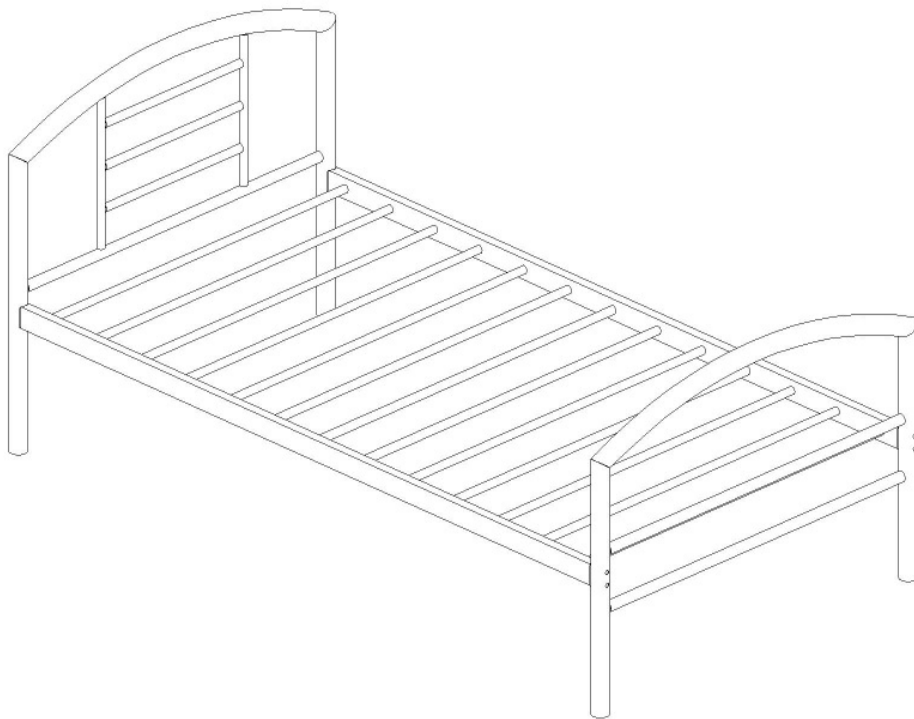

Fine Furniture for every stage of life

400157T

Twin Bed

COASTERFURNITURE.COM

ITEM:400157T



ASSEMBLY INSTRUCTIONS

ASSEMBLY TIPS:

1. Remove hardware from box and sort by size.
2. Please check to see that all hardware and parts are present prior to start of assembly.
3. Please follow attached instructions in the same sequence as numbered to assure fast & easy assembly.



WARNING!



1. Don't attempt to repair or modify parts that are broken or defective. Please contact the store immediately.
2. This product is for home use only and not intended for commercial establishments.



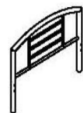

ASSEMBLY TIME

15 MINUTES

PARTS IDENTIFICATION

A	HEADBOARD		1PC	C	BED FRAME		1PC
B	FOOTBOARD		1PC				

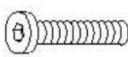
HARDWARE IDENTIFICATION

1	BOLT 5/16X60mm		8PC	3	ALLEN KEY 5mm		1PC
2	WASHER 8.2		8PC				

ASSEMBLY INSTRUCTIONS

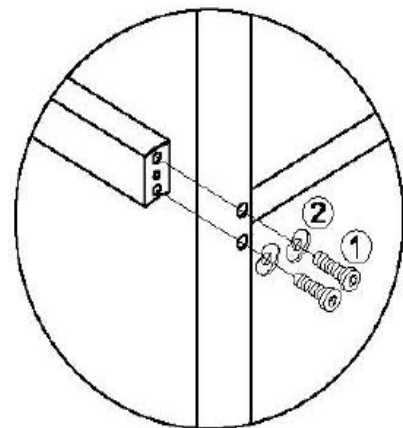
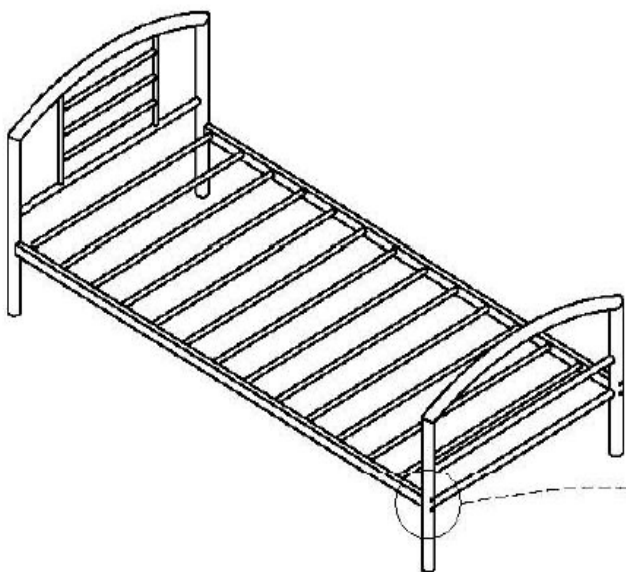

NOTE:

Phillips head screw driver is required in the assembly process; however, manufacturer does not provide this item.

ITEM: **400157T**

PRODUCT DIMENSION:

