





# ASSEMBLY INSTRUCTION

## LEFT SIDE RECLINING LOVE SEAT WITH CENTER CONSOLE

ITEM NO: 9599GRY-2LCN/9599BRW-2LCN

**NOTE:** Do not use power tools for assembly. Power tools increase the risk of over tightening which lead to splitting or cracking the wood.

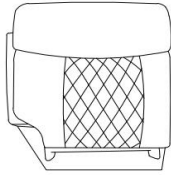
### COMPONENT LIST

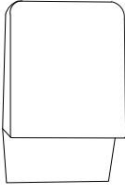
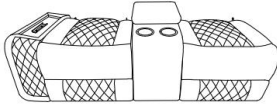
NO.	DRAWING	QTY	DESCRIPTION
A		1	LSF ARM
B		1	LSF BACK REST
C		1	RSF BACK REST
D		1	CONSOLE BACK REST
E		1	SEAT

**Please follow the drawings below to assemble the item.**

**Step 1. Console back rest is stored in plastic bag at the bottom of the console. Please take out for assembly.**

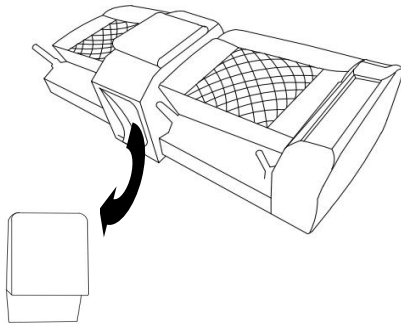

**Step 2. Insert the female brackets at the arm cushion onto the male brackets at the seat, insert and push to the end, make sure the brackets are secured in position.**

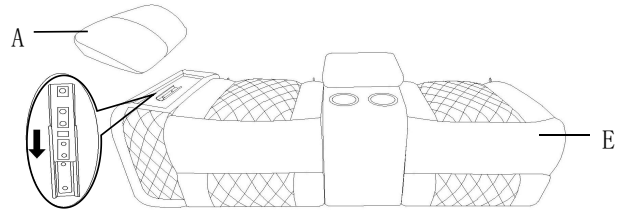

**Step 3. Align the female brackets at the back rest onto the male brackets at the seat, insert and push to the end, make sure the brackets are secured in position.**

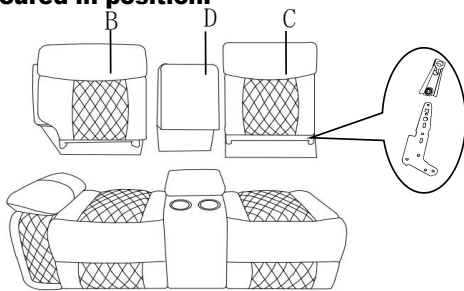

**Step 4. Completed**

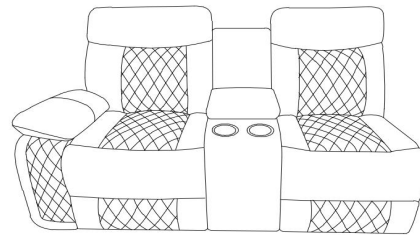

**Step 5.**

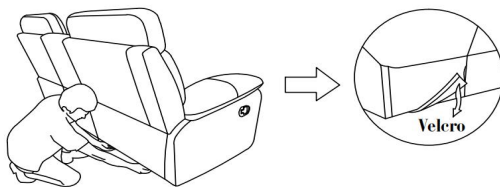

**Step 6. Pull open handle to use reclining function**

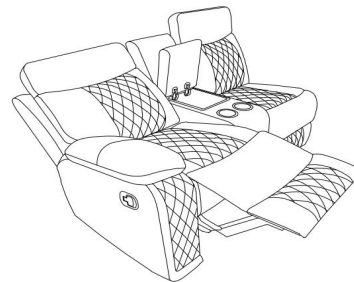

**CARE INSTRUCTION FOR LEATHER GEL:**

**In order to maintain the original appearance of your leather gel furniture, please follow below simple care procedure :**

- **Avoid exposing furniture directly to sunlight or heating and air conditioning outlets. Exposure to sunlight or heating and air conditioning outlets will fade/damage leather gel.**
- **Wipe gently with a damp soft cloth to remove dust, dirt and any grime build up.**

**PLEASE KEEP ASSEMBLY INSTRUCTION FOR FUTURE REFERENCE**



# ASSEMBLY INSTRUCTION

## CORNER SEAT

ITEM NO: 9599GRY-CR/9599BRW-CR

**NOTE:** Do not use power tools for assembly. Power tools increase the risk of over tightening which lead to splitting or cracking the wood.

### COMPONENT LIST

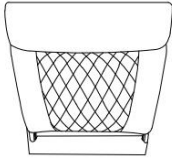
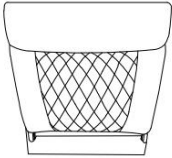
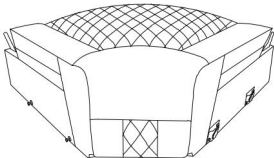
NO.	DRAWING	QTY	DESCRIPTION
A		1	LSF BACK REST
B		1	RSF BACK REST
C		1	SEAT

**Please follow the drawings below to assemble the item.**

**Step 1. Align the female brackets at the back rest onto the male brackets at the seat, insert and push to the end, make sure the brackets are secured in position.**

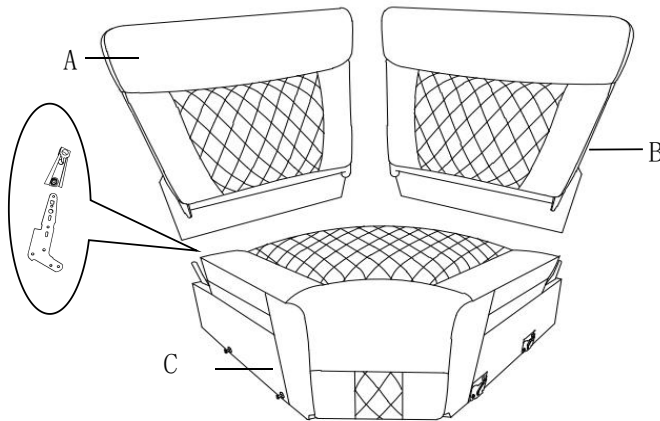

**Step2. Completed**

**Step3.**

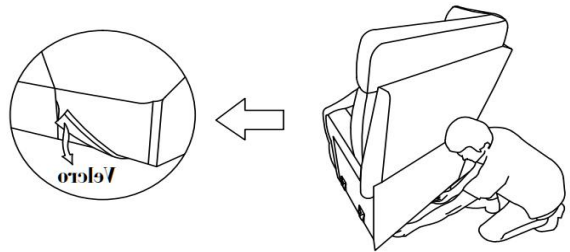
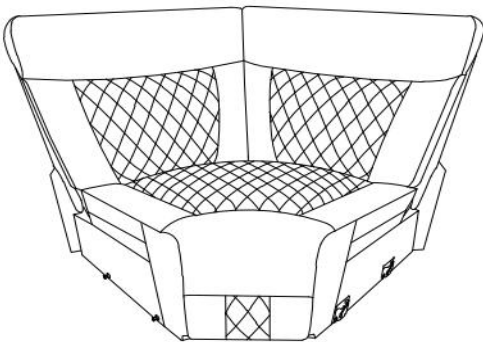

**CARE INSTRUCTION FOR LEATHER GEL:**

**In order to maintain the original appearance of your leather gel furniture, please follow below simple care procedure :**

- **Avoid exposing furniture directly to sunlight or heating and air conditioning outlets. Exposure to sunlight or heating and air conditioning outlets will fade/damage leather gel.**
- **Wipe gently with a damp soft cloth to remove dust, dirt and any grime build up.**

**PLEASE KEEP ASSEMBLY INSTRUCTION FOR FUTURE REFERENCE**





# ASSEMBLY INSTRUCTION

## RIGHT SIDE RECLINING LOVE SEAT

ITEM NO: 9599GRY-2R/9599BRW-2R

**NOTE:** Do not use power tools for assembly. Power tools increase the risk of over tightening which lead to splitting or cracking the wood.

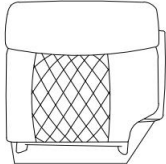
### COMPONENT LIST

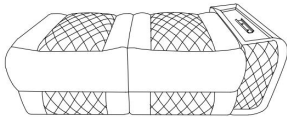
NO.	DRAWING	QTY	DESCRIPTION
A		1	RSF ARM
B		1	RSF BACK REST
C		1	LSF BACK REST
D		1	SEAT

**Please follow the drawings below to assemble the item.**

**Step 1. Insert the female brackets at the arm cushion onto the male brackets at the seat, insert and push to the end, make sure the brackets are secured in position.**

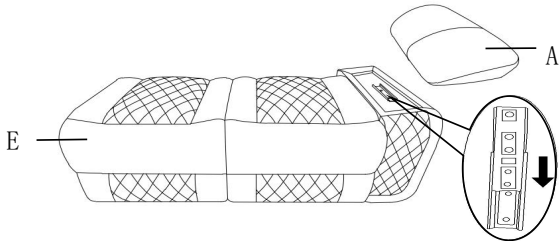

**Step 2. Align the female brackets at the back rest onto the male brackets at the seat, insert and push to the end, make sure the brackets are secured in position.**

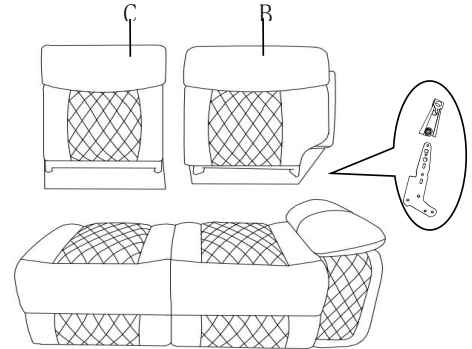

**Step 3. Completed**

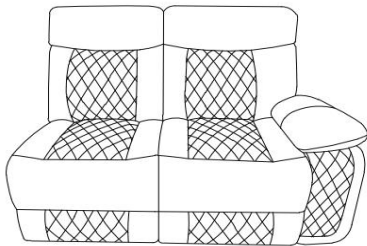

**Step 4. Pull open handle to use reclining function**



**Step 5.**

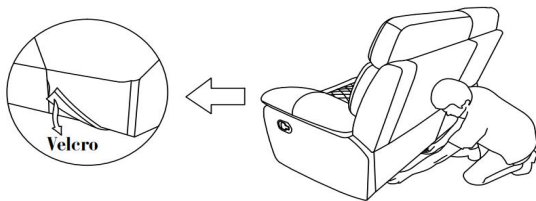

**Step 6. Combine -2LCN/CR/2R to a whole set group**

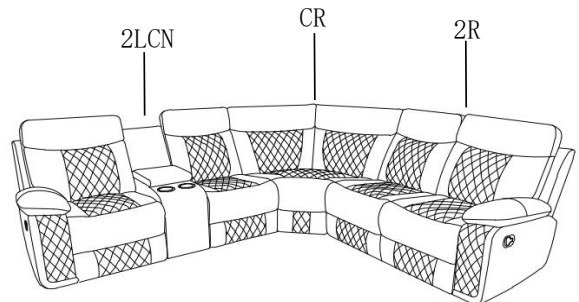

**CARE INSTRUCTION FOR LEATHER GEL:**

**In order to maintain the original appearance of your leather gel furniture, please follow below simple care procedure :**

- **Avoid exposing furniture directly to sunlight or heating and air conditioning outlets. Exposure to sunlight or heating and air conditioning outlets will fade/damage leather gel.**
- **Wipe gently with a damp soft cloth to remove dust, dirt and any grime build up.**

**PLEASE KEEP ASSEMBLY INSTRUCTION FOR FUTURE REFERENCE**