



Assembly Instruction

ITEM NO.:9540GY-VT

2-SEATER WITH PULL OUT BED

ITEM NO.:9540GY-VC



CHAISE WITH STORAGE



Legs & hardware are stored at the bottom of sofa, please take out the legs and hardware for assembly.

Note: Do not use power tools for assembly. Power tools increase the risk of over tightening which lead to splitting or cracking the wood.

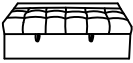
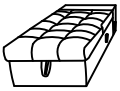
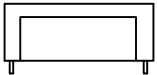
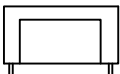
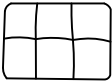
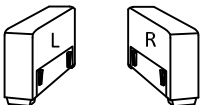
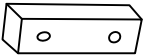
Component list (2-Seater & Chaise)

No	Drawing	Qty	Description
A		1	VT 2-SEATER SEAT
B		1	VC CHAISE SEAT
C		1	VT 2-SEATER BACK REST
D		1	VC CHAISE BACK REST
E		3	VT/VC BACK CUSHION
F		2	LSF/RSF ARM
G		2	VC Plastic leg 5-7/8"*2"*2"
H		2	VC plastic feet 2-1/8"*2"
I		6	Screw 1/5"*2"

Step #1 Please take out parts which stored inside the seat for assembly.

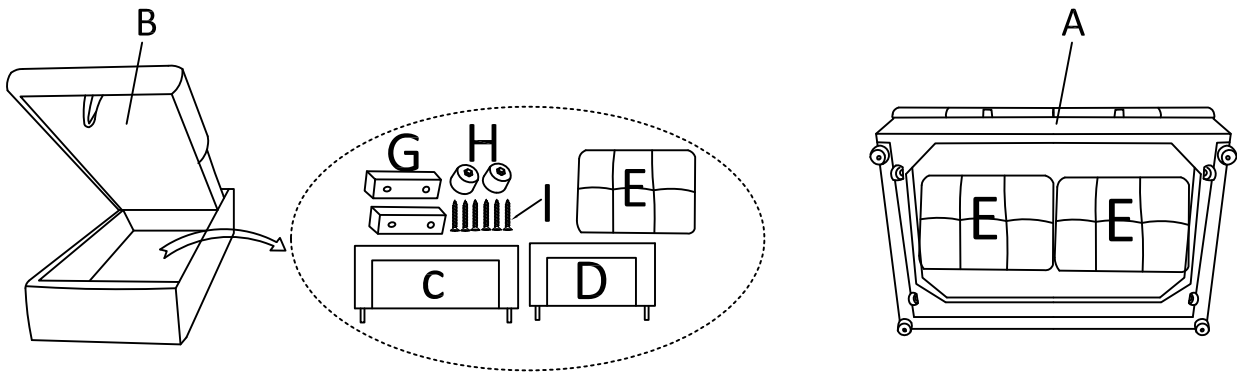

Step #2 Align legs to the pre-drilled holes, insert screws and tighten with screw driver.

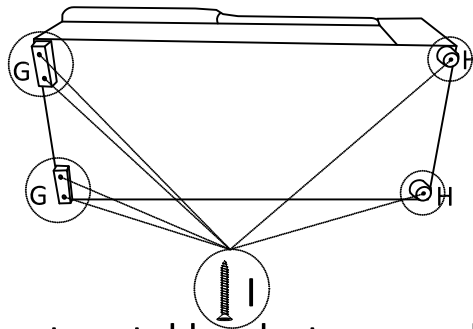

Step #3 Align and connect metal hooks to assemble the sectional.

Option A

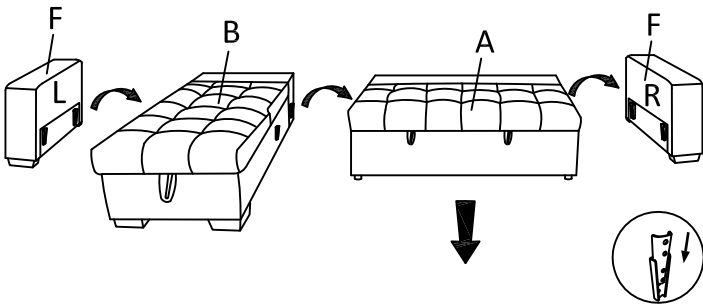

Option B

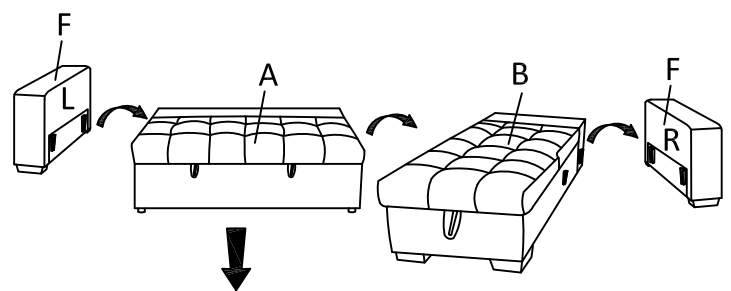

Step #4 Align and insert all brackets on back rest to seat, push to the end to secure in place properly.

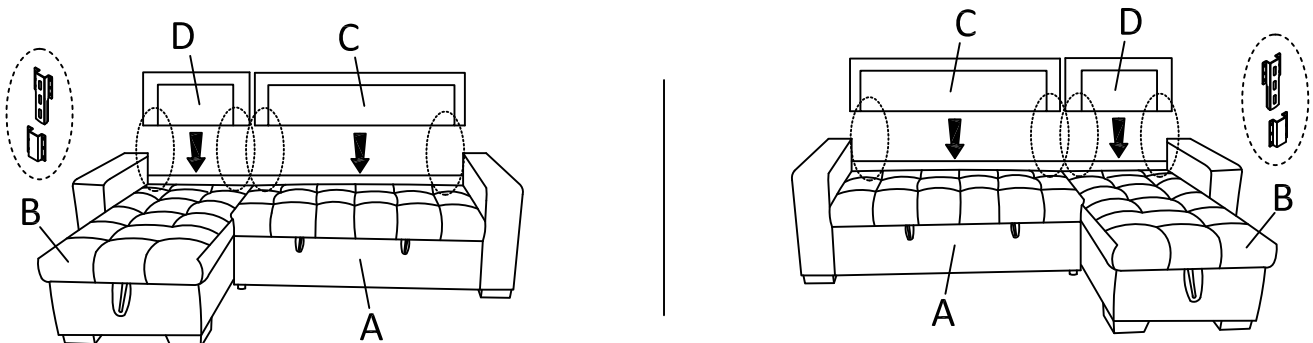

Step #5 Align back cushion onto the back rest, attach Velcro and adjust the position properly.

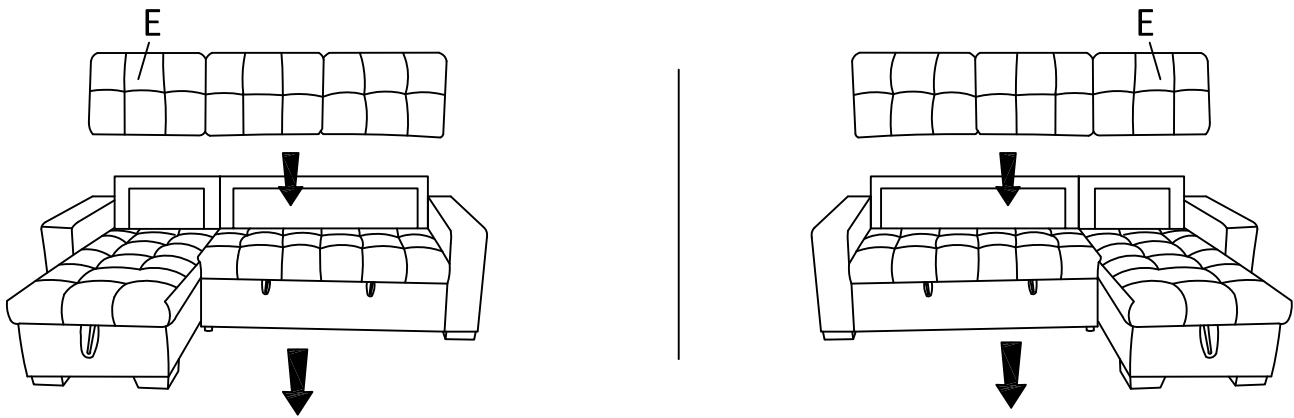

Step #6 Sectional assembly is completed.

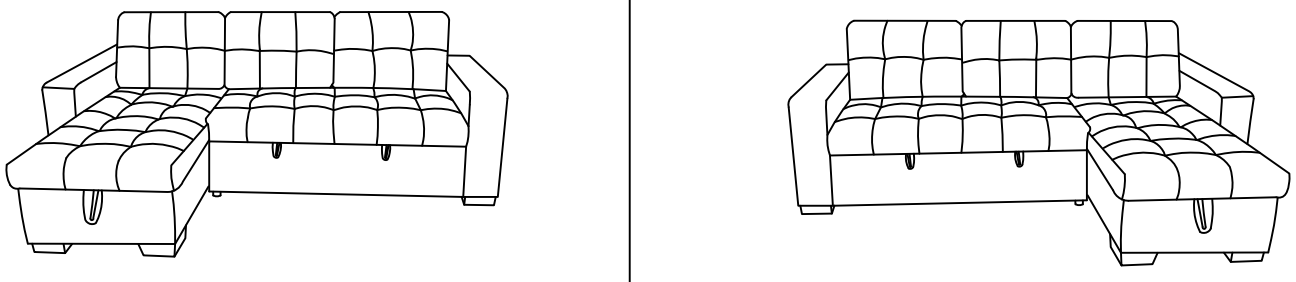

Care Instruction for Fabric/Pu Furniture:

In order to maintain the original appearance of your Fabric and Pu Furniture, please follow below simple care procedures:

- Avoid exposing furniture directly to sunlight or heating and air conditioning outlets. Sunlight and or exposure to heating and air conditioning outlets will fade/damage Fabric.
- Vacuum or wipe with a soft cloth to remove dust.
- Clean Fabric with professional cleanser.



For items use on wooden floor, hard surfaces or carpets, it is recommended to Install protective pads under all legs and supports to avoid/prevent from damages/scratches and discoloration.