

ASSEMBLY INSTRUCTION FOR ACME FURNITURE

MODEL# 52422,52427 CHAIR

Thank you for purchasing this quality product. Be sure to check all packing material carefully for small parts which may have come loose inside the carton during shipment. Separate, identify and count all parts and metal hardware. Compare with parts list to be sure all parts are present. If any part(s) are missing or damaged, please contact your local furniture dealer. For efficient and speedy service, please indicate the model number and code letter of part(s) needed.

***** Do not fully tighten screws until fully assembled *****

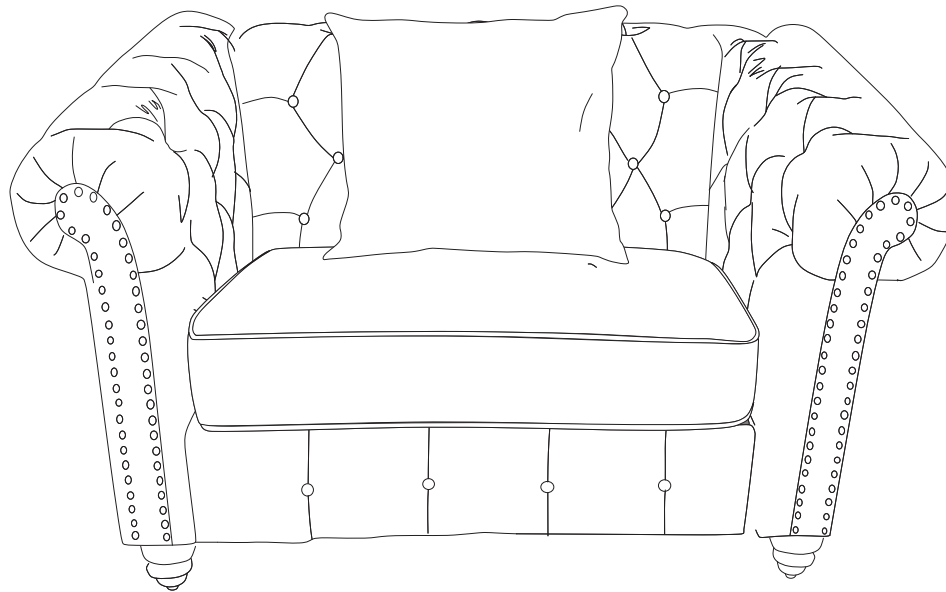

Parts List

A

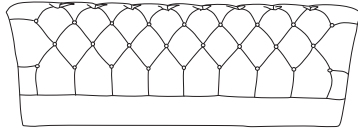

BACKREST

BL

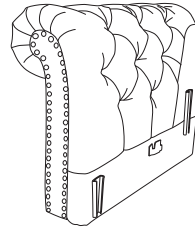

ARM LEFT

BR

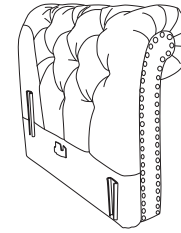

ARM RIGHT

C



THWART

D

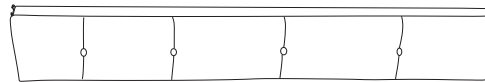

SIT FRONT PANEL

E



Pillow x1

F

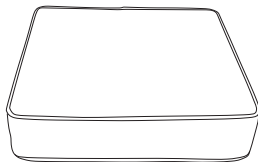

CUSHION X1

G

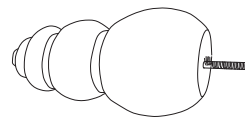

Wood Leg x4

H

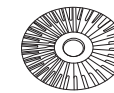

Plastic Washer x4

Figure1

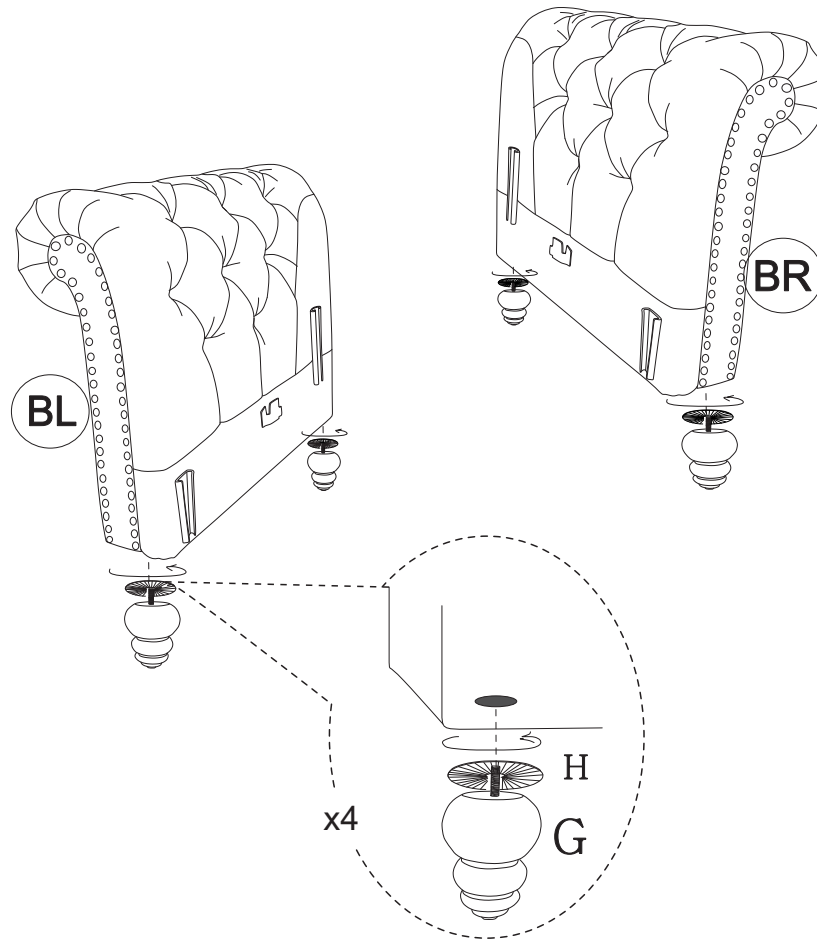

Figure2

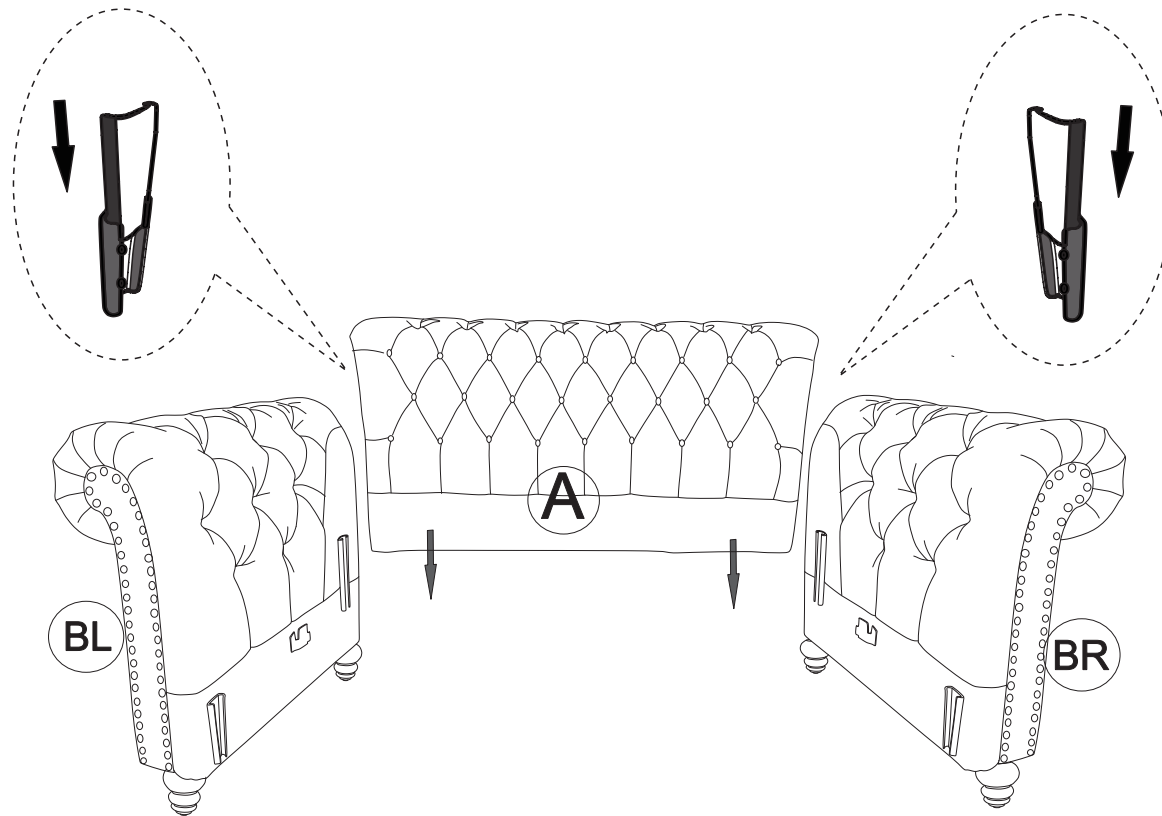

Figure 3

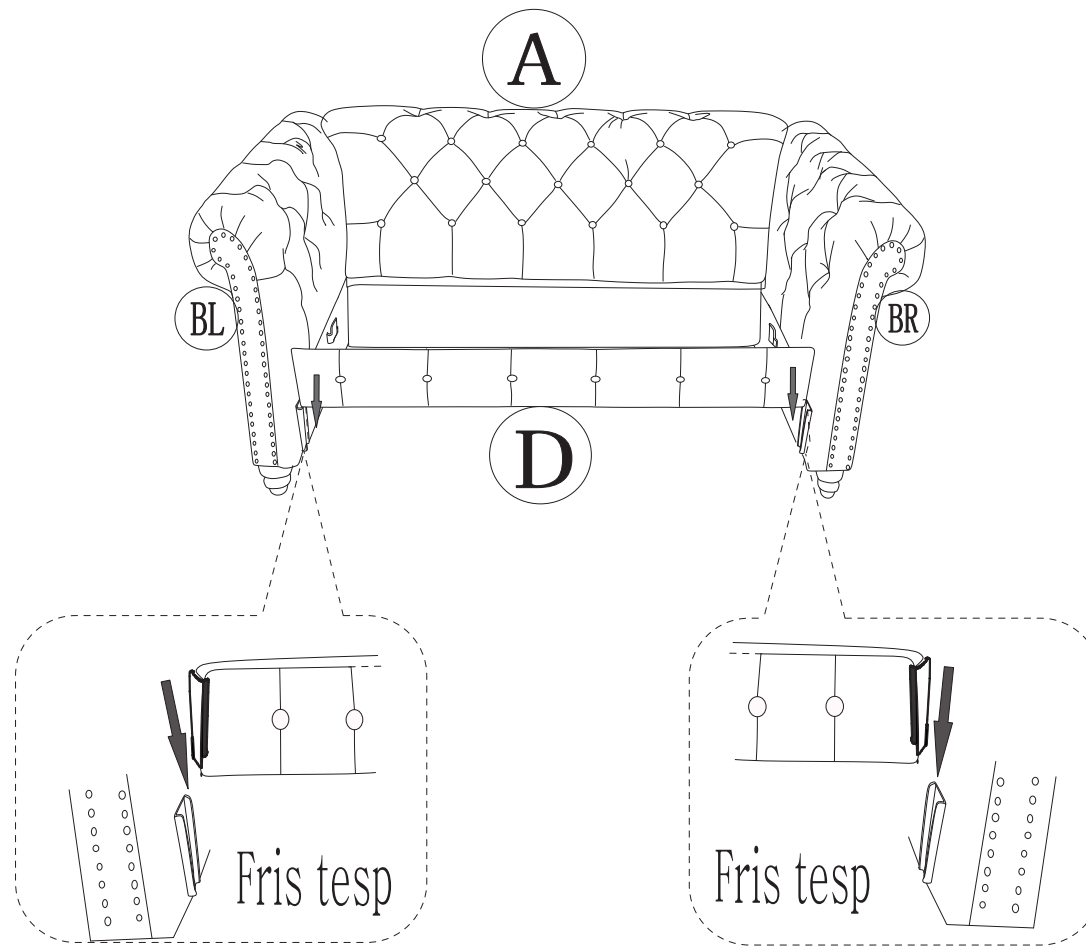

Figure 4

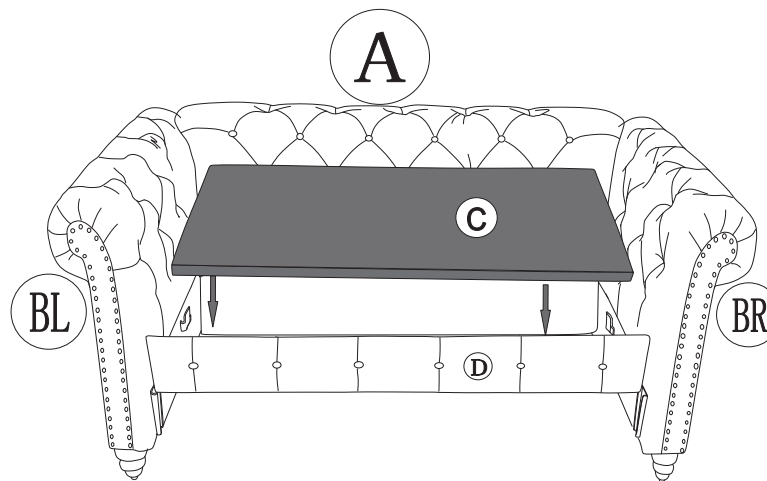
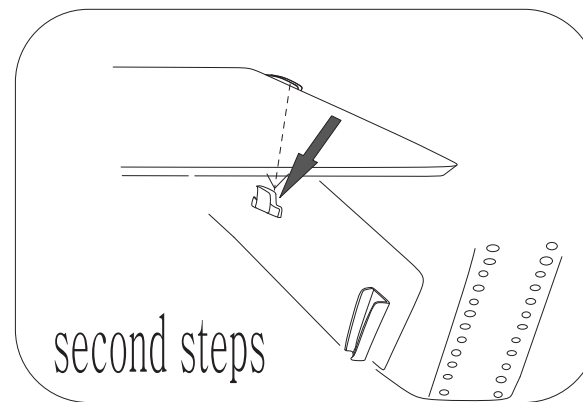
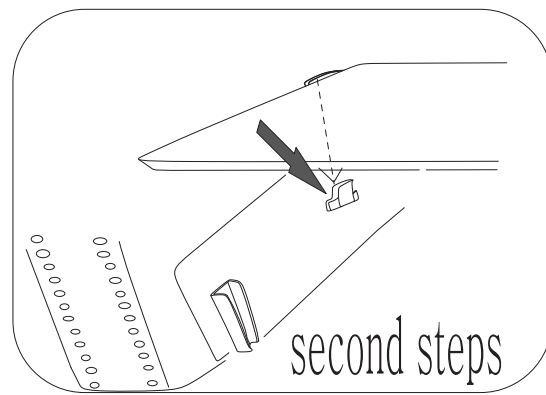
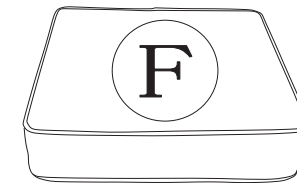
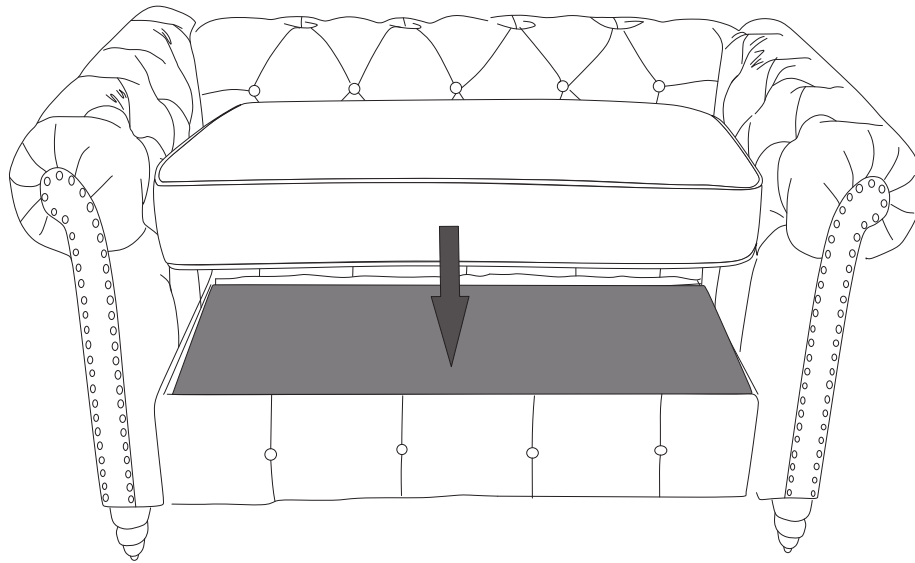
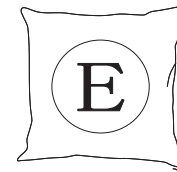
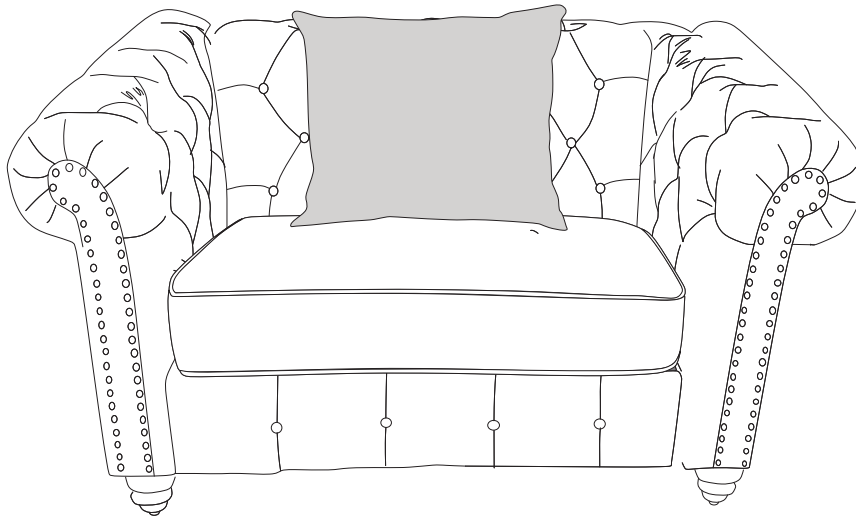

Figure 5



CUSHION X1

Figure 6



Pillow x1