

Electric Recliner Assembly Instruction

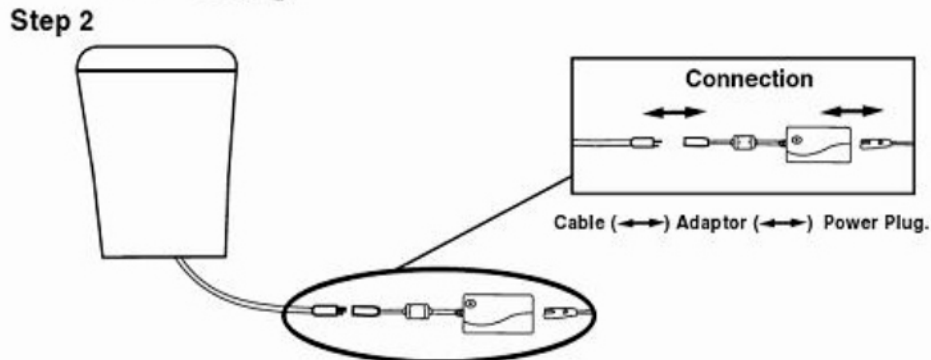

Electric Reclining Sofa Assembly Instruction (3RR)

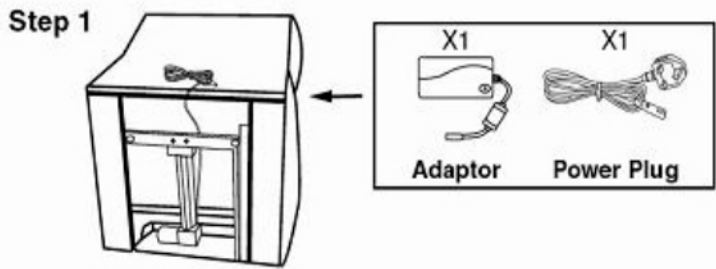
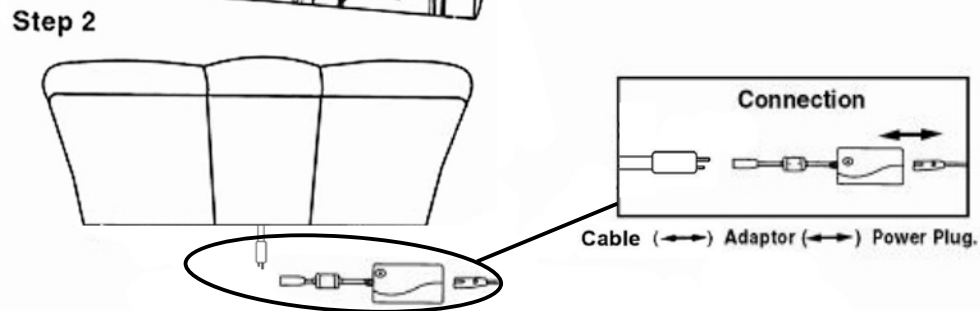
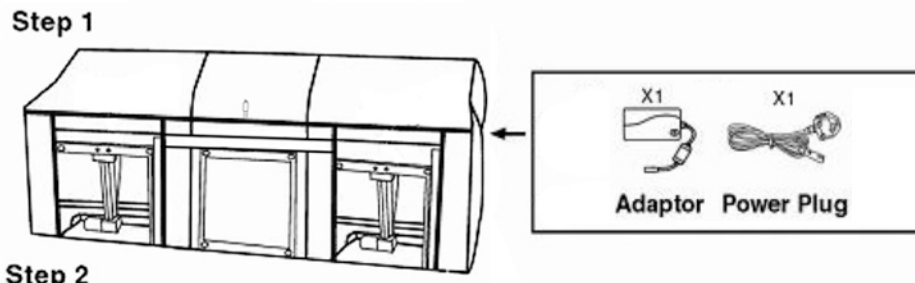

Electric Reclining Sofa Assembly Instruction (2RR)

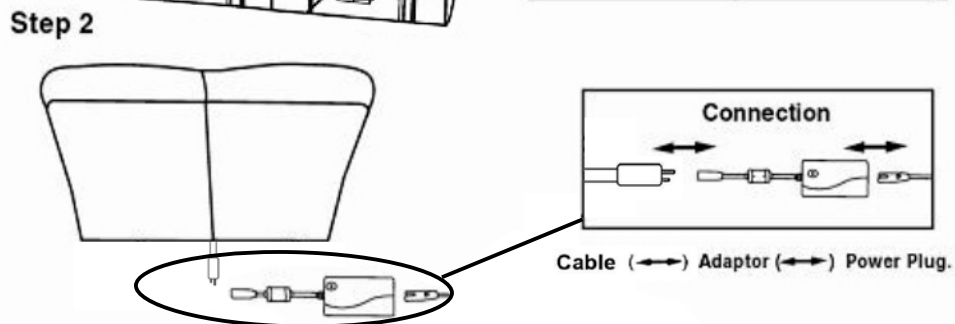
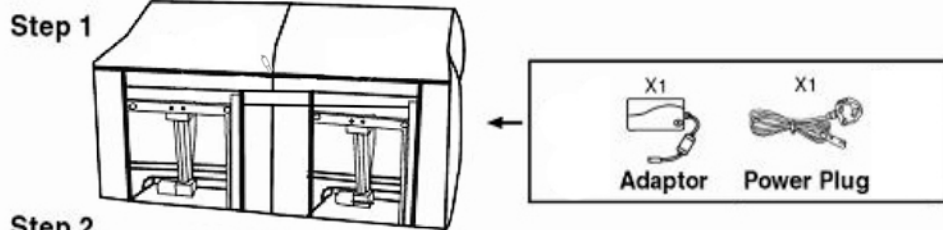

Electric Sectional Corner Group Assembly Instruction

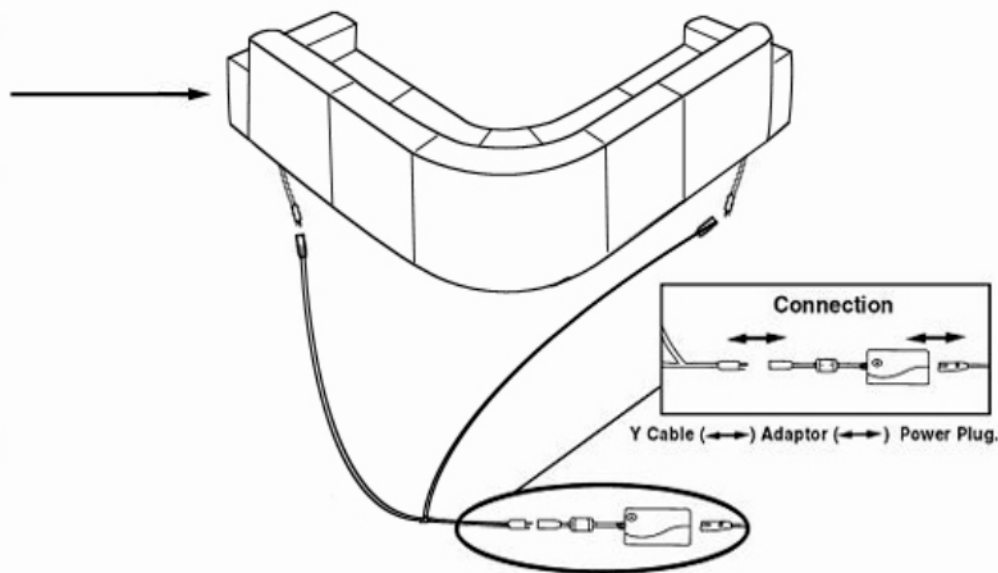

Where To Locate The Arm Cushions

A) Recliner Chair

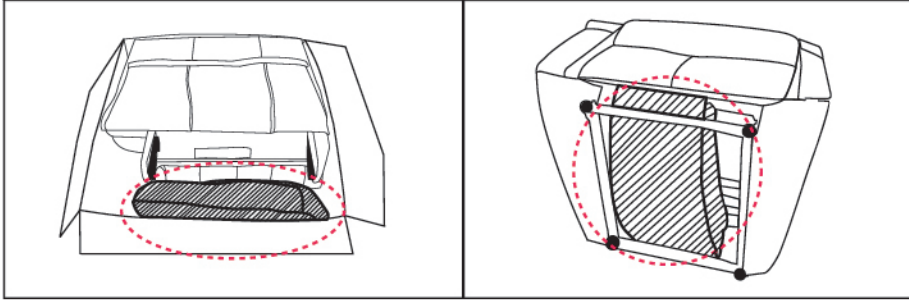

B) Recliner Chair With Electric Motor

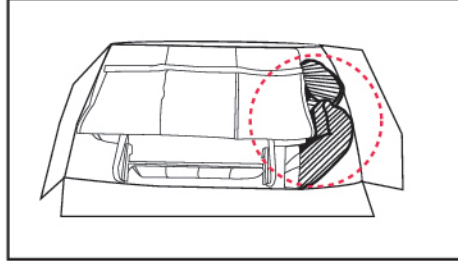

C) Left / Right Recliner With & Without Electric Motor

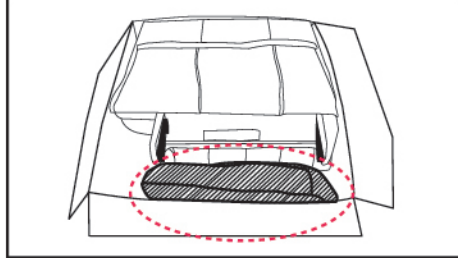

Arm Cushions Assembly Instruction

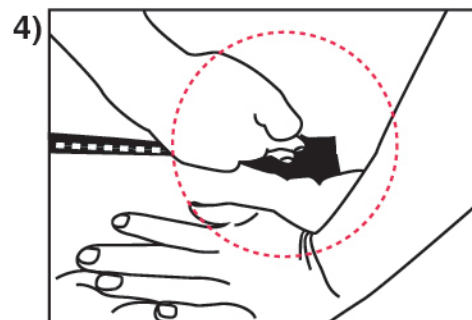
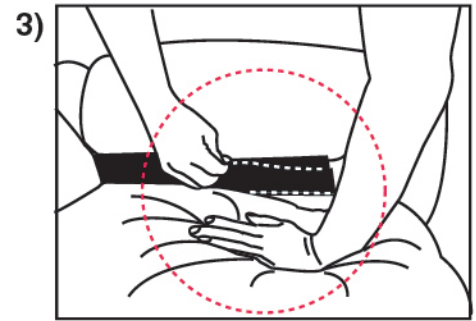
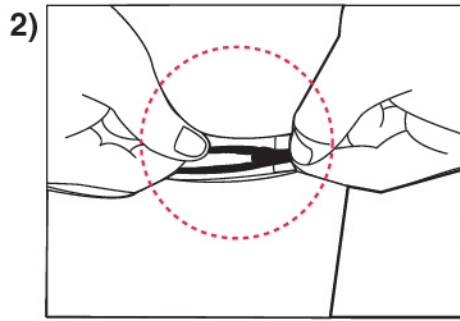
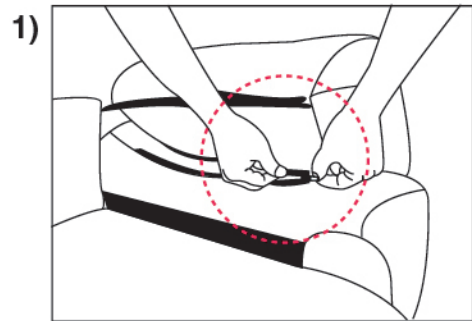

BACK ASSEMBLY INSTRUCTIONS RECLINER/MOTION UPHOLSTERY

CAUTION

PLEASE READ ALL INSTRUCTIONS CAREFULLY BEFORE STARTING ASSEMBLY PROCESS
IT IS RECOMMENDED TO USE TWO PEOPLE WHEN ASSEMBLING AND REMOVING THE INSIDE BACKS TO AND FROM THE BASE OF THE FURNITURE.

STEP 1:

Slide inside back receivers into the steel mechanisms posts in the base of the furniture (Figure A).

STEP 2:

Press both sides of the inside back firmly into place. The inside back automatically locks into place.

STEP 3:

To remove the inside backs, use a screwdriver pressing outward on the black tab in the metal sleeve (Figure B) on both sides of the inside back and lift the inside back from the base of the furniture.

MOBILIER REMBOURRÉ INCLINABLE INSTRUCTIONS D'ASSEMBLAGE DES DOSSIERS

MISE EN GARDE:

NOUS VOUS PRIONS DE LIRE LES INSTRUCTIONS D'ASSEMBLAGE AU COMPLET AVANT DE COMMENCER L'ASSEMBLAGE.
NOUS RECOMMANDONS QUE DEUX PERSONNES PROCÈDENT À L'ASSEMBLAGE OU AU DÉSASSEMBLAGE DES MOBILIERS

ÉTAPE N° 1:

Glisser la tige mâle dans l'attache métallique femelle située au bas du côté du dossier amovible. (Voir schéma A)

ÉTAPE N° 2:

Pousser sur les deux côtés du dossier intérieur pour bien le mettre en place. Le dossier intérieur se fixe automatiquement.

ÉTAPE N° 3:

Pour enlever le dossier intérieur, utiliser un tournevis et pousser vers l'extérieur sur la languette noire à l'intérieur de la gaine métallique (voir schéma B), et ce, sur les deux côtés du dossier intérieur, puis soulever celui-ci à la base du meuble.

INSTRUCCIONES PARA ARMAR LA PARTE POSTERIOR DE UN SILLÓN RECLINABLE MOVIBLE TAPIZADO

PRECAUCIÓN:

POR FAVOR LEA CUIDADOSAMENTE TODAS LAS INSTRUCCIONES ANTES DE EMPEZAR EL PROCESO DE ARMAR.
SE RECOMIENDA USAR DOS PERSONAS PARA ARMAR O QUITAR LAS PARTES POSTERIORES INTERNAS DE LA BASE DEL MUEBLE.

PASO 1:

Deslice los recibidores internos de la parte posterior dentro de los postes del mecanismo de acero en la base del mueble (Ilustración A).

PASO 2:

Presione firmemente en sus lugares ambos lados de la parte posterior interna. La parte posterior interna se introduce automáticamente en su sitio.

PASO 3:

Para quitar la parte posterior interna use un destornillador y presione hacia afuera en la pestaña negra del manguito de metal (Ilustración B) en ambos lados de la parte posterior interna y levante la parte posterior interna de la base del mueble.

